

exkal

e FOR FUTURE GENERATIONS

VITRINAS FISH

SOSTENIBLE Y MONOCASCO / SUSTAINABLE AND MONOBLOCK /
DURABLE ET MONOCOQUE / NACHHALTIG UND MONOBLOCK

■ **VISIÓN PRODUCTO** / PRODUCT VISIBILITY / VISIBILITÉ PRODUITS /
PRODUKPRÄSENTATION

ERGONOMÍA / ERGONOMY / ERGONOMIE / ERGONOMIE & DREHTÜR

OPTIMIZACIÓN ESPACIO VENTA / RETAIL FOOTPRINT
OPTIMIZATION / RETAIL FOOTPRINT OPTIMISATION /
VERKAUFSFLÄCHENOPTIMIERUNG

■ **ÁREA TOTAL EXPOSICIÓN** / TOTAL DISPLAY AREA / TDA / TDA

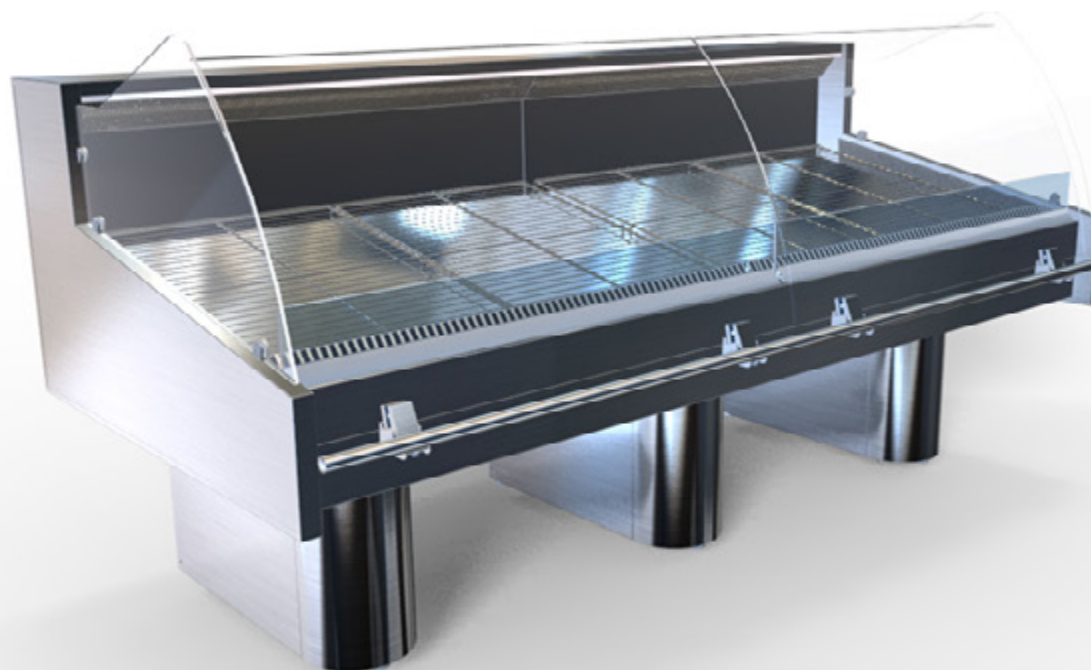

FISH

VITRINAS**REMOTOS**

exkalsa.com



	2			3			4			5			6		
mm	1250			1875			2500			3125			3750		
	TDA	Vol	Suf	TDA	Vol	Suf	TDA	Vol	Suf	TDA	Vol	Suf	TDA	Vol	Suf
	m ²	m ³	m ²	m ²	m ³	m ²	m ²	m ³	m ²	m ²	m ³	m ²	m ²	m ³	m ²
FHAMR	1,33	225	1,04	1,99	338	1,56	2,65	450	2,08	3,32	563	2,6	3,98	675	3,12
FHAMC	1,33	225	1,04	1,99	338	1,56	2,65	450	2,08	3,32	563	2,6	3,98	675	3,12
FHSMC	1,31	225	1,04	1,97	338	1,56	2,63	450	2,08	3,29	563	2,6	3,94	675	3,12
FHAMRN/A	1,44	293	1,54	2,16	439	2,31	2,88	586	3,08	3,6	732	3,85	4,31	878	4,62
FHAMCN/A	1,42	293	1,54	2,13	439	2,31	2,84	586	3,08	3,55	732	3,85	4,25	878	4,62
FHSMCN/A	1,42	293	1,54	2,14	439	2,31	2,84	586	3,08	3,56	732	3,85	4,26	878	4,62

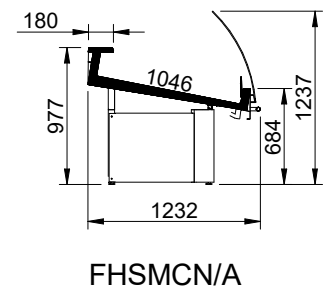
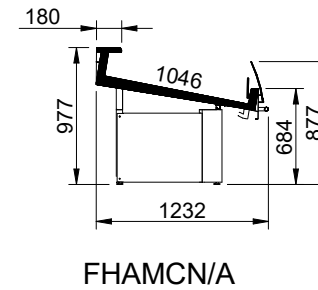
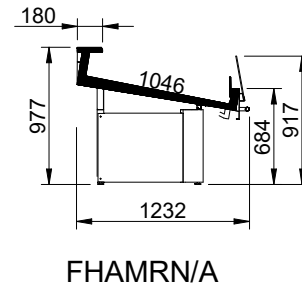
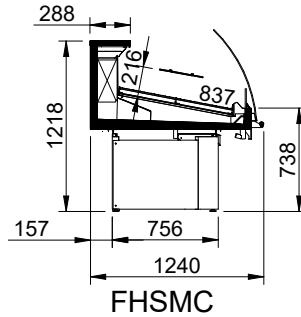
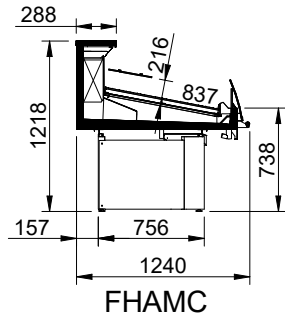
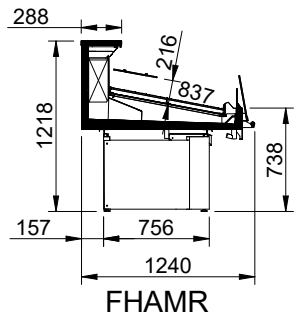

TDA = Área Total de Exposición / Total Display Area / Zone d'affichage totale / Gesamtausstellungsfläche • Vol = Volumen neto / Net volume / Volume net / Nettovolumen • Suf = Superficie de exposición / Exhibition surface / Surface d'exposition / Ausstellungsfläche.
Best energy class model. More information at EPREL or contact our Sales Department.

ECOLABEL - REGLAMENTO (UE) 2019/2024 DE LA COMISIÓN de 1 de octubre de 2019, artículo 1: 3. Los requisitos del punto 1 y del punto 3, letra k), del anexo II no se aplican a: g) los mostradores de pescadería con hielo en escamas.



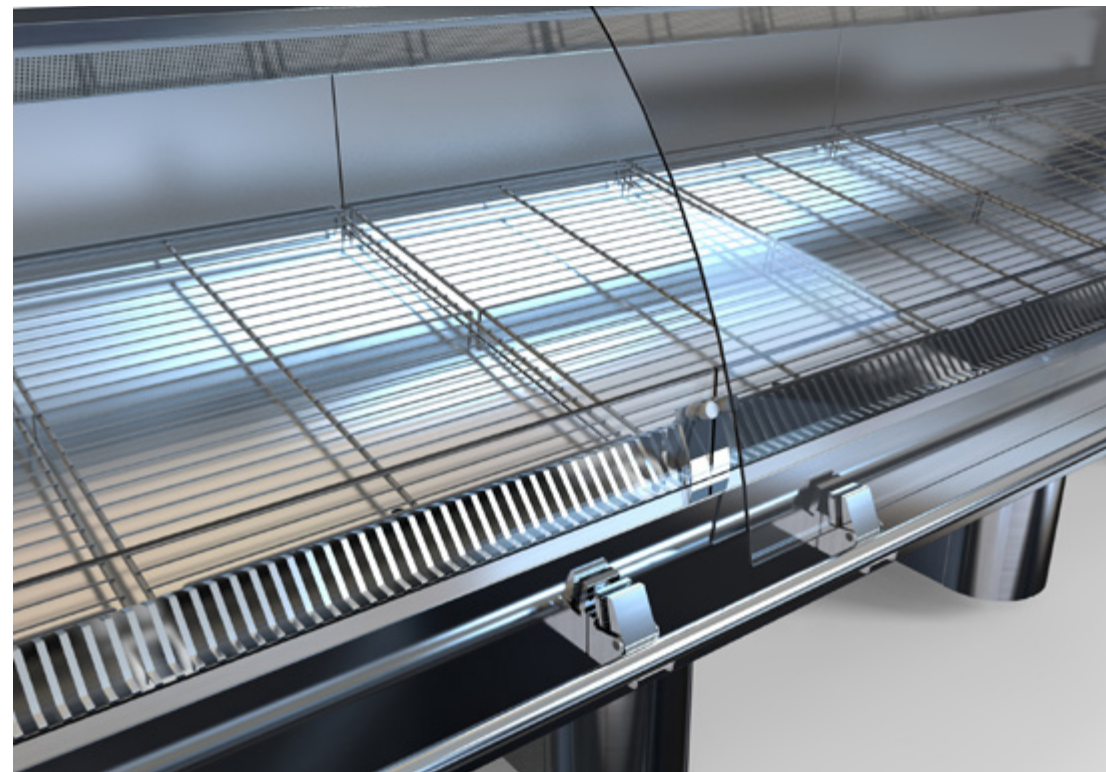
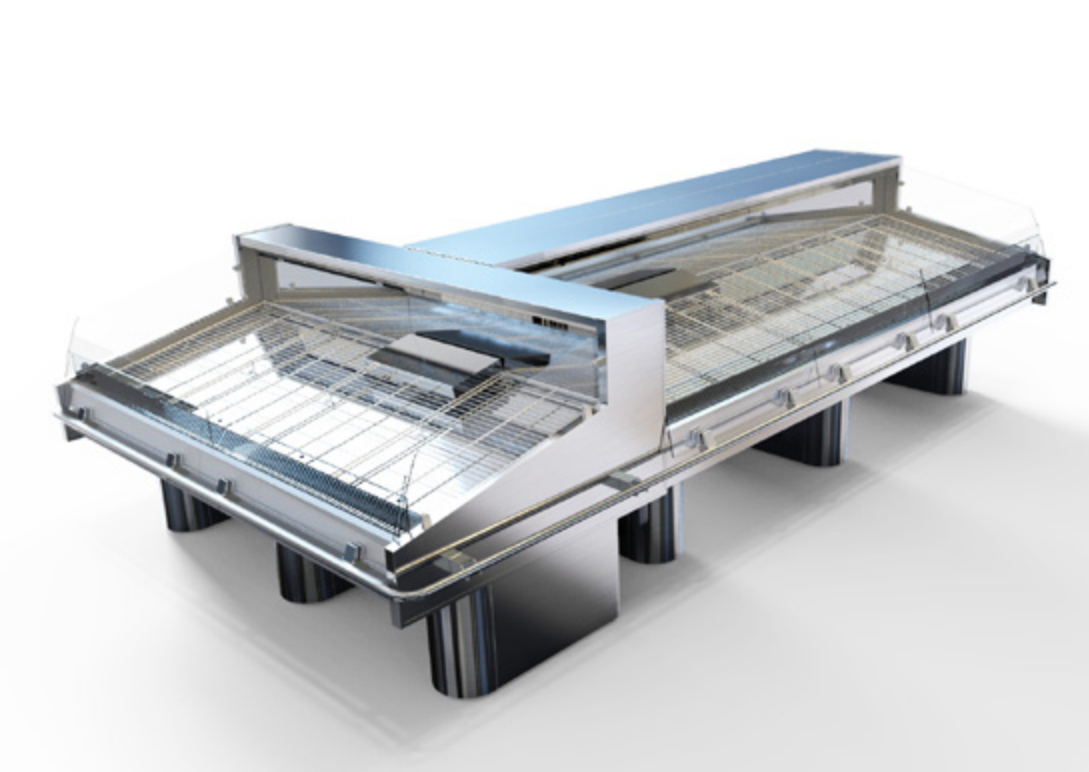
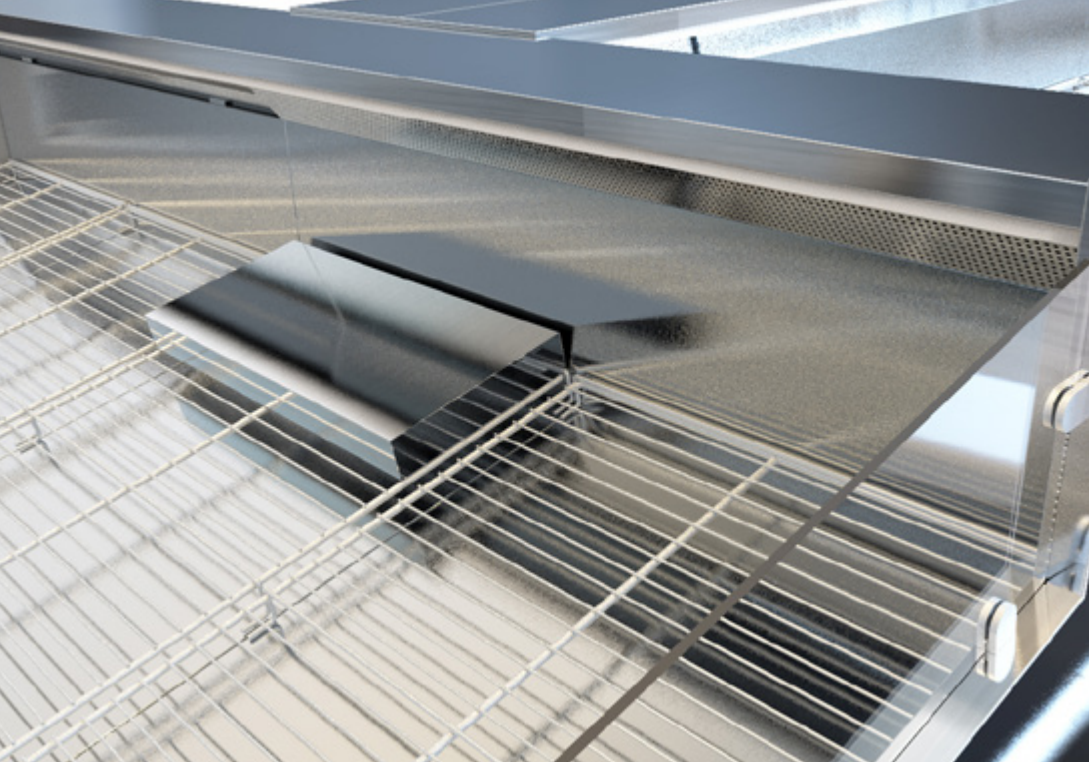

EVAPORATOR

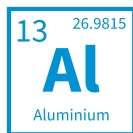
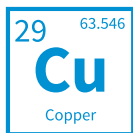
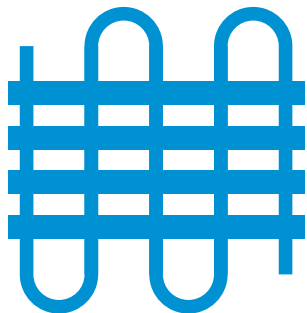

MONOBLOCK



exkal

FOR FUTURE GENERATIONS

Pol. Ind. El Campillo, C/A Nº 1, 31340, Marcilla, Navarra
(España - Spain)
+34 948 708 292 | exkalsa@exkalsa.com | exkalsa.com

exkal
CONCEPT

exkalconcept.com

horexkal



horexkal.com

